

LIFT-ASSIST DAMPER

LAD



- Great solution for counter flaps at bars, restaurants, and receptions.
 - Built-in damper provides soft closing near closing radius, preventing slamming.
 - Damper will function even if released close to closing radius.
 - Lift-assist makes counter flaps feel light and easy to lift.
 - Can be retrofitted to existing counter flaps without a mortise.
 - Easy to align installation position using the included template.
 - Thin profile. When opened, unit has very small 35mm protrusion.
 - Successfully passed 100,000 open/close cycles in a private test.
 - Suitable flap thickness: 15 - 25mm.
- Maximum possible flap thickness by using spacer LAD-DP is 40 mm.

Винт со сферической головкой 4×16

Скрытая шарнирная петля R

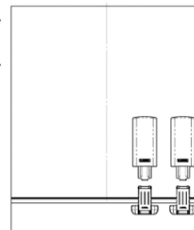
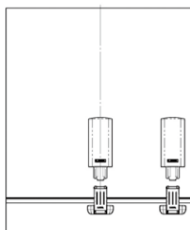
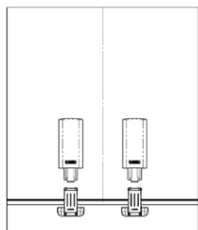
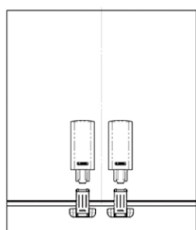
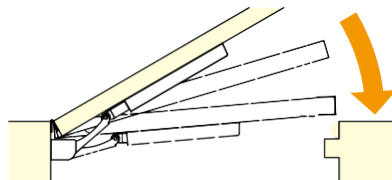
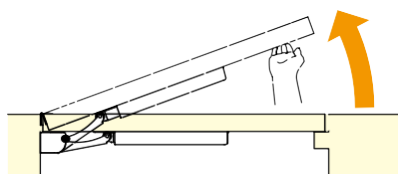
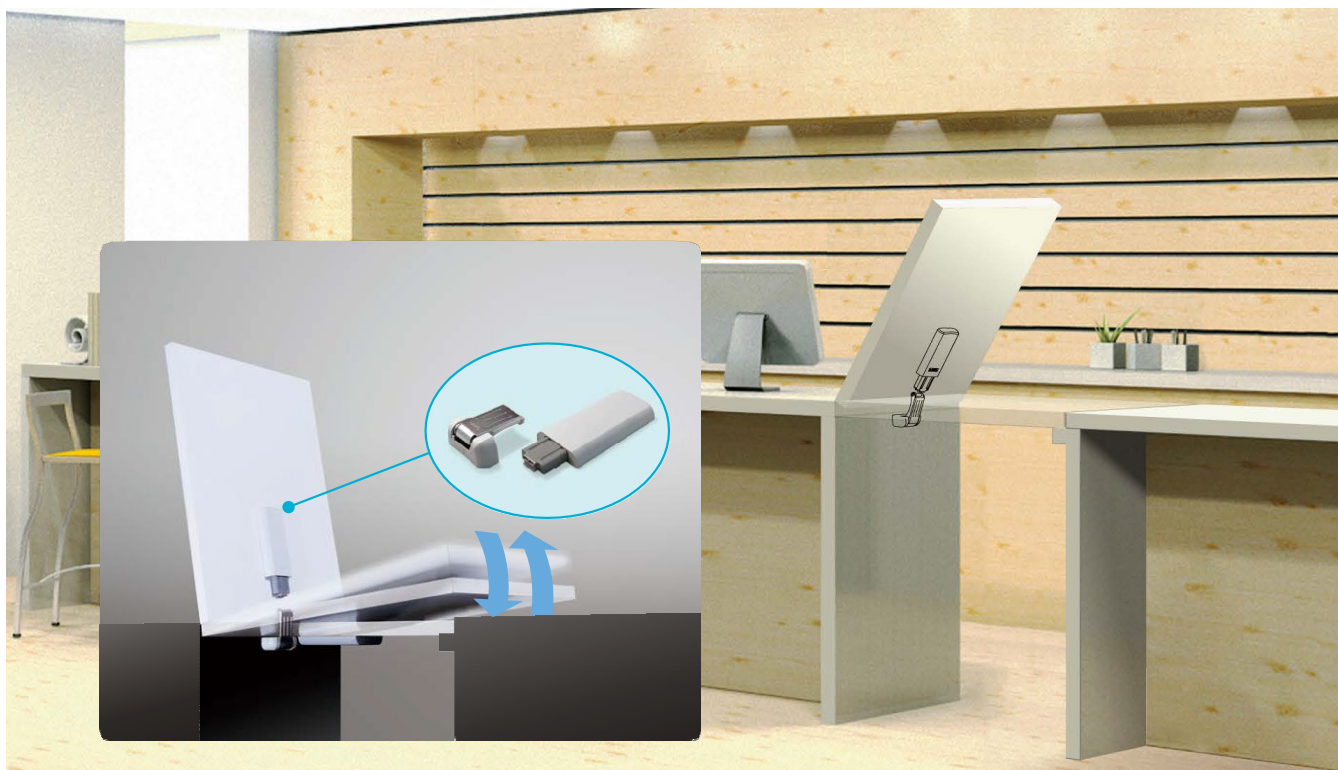

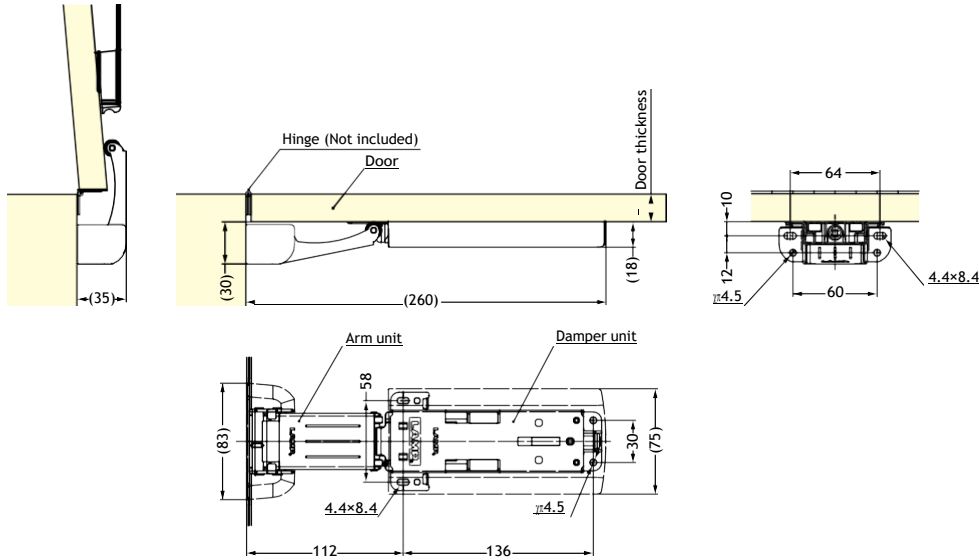

Door Size Ranges: 1 pc Use (*2 pcs use possible. Torque moment becomes double.)

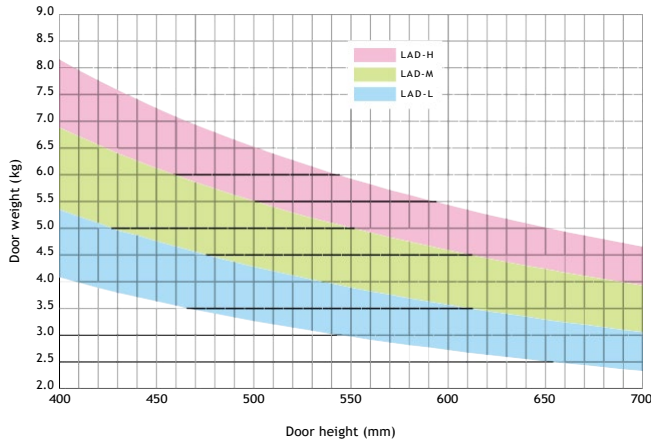

Item Code	Item Name	Material	Finish	Torque Moment/piece	Door Thickness	Weight	Carton
170-025-804	LAD-L	ABS/	Zincing/Nickel Chrome	8.0 - 10.5 N·m (81.6 - 107.1 kgf·cm)	15 - 25	545 g	20 pcs
170-025-805	LAD-M	Polyacetal (POM)/		10.5 - 13.5 N·m (107.1 - 137.7 kgf·cm)		568 g	
170-025-806	LAD-H	Steel		13.5 - 16.0 N·m (137.7 - 163.2 kgf·cm)		571 g	

SPACER

For over 25 mm thickness door.

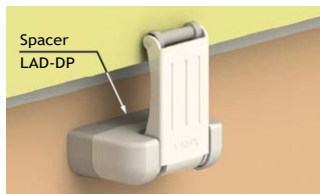

Features
For counter flaps with a thickness greater than 25mm.

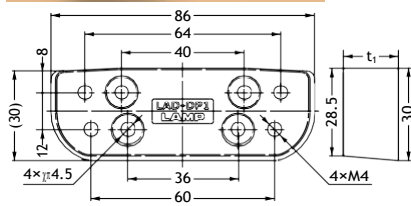
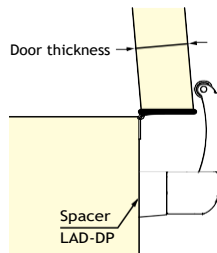

Item Code	Item Name	t ₁	Door Thickness	Material	Colour
170-028-234	LAD-DP1	18	25 - 35	Polyacetal	Grey
170-028-235	LAD-DP2	25	30 - 40	(POM)	

LAD-DP

BRACKET FOR BACK MOUNT LAD-BKT

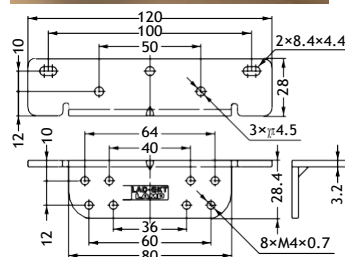
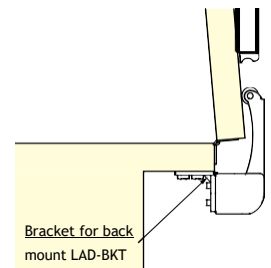
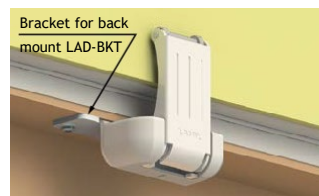

Item Code	Item Name	Material	Colour
170-028-236	LAD-BKT	Steel (SPCC)	Nickel